

# NEW

## PRODUCTS Aug.2016

### Touch Dimmer Controller



Modern lifestyle requires more and more minimalism in interior design. With super flat configuration, SELF touch sensor KZQ-CM-BC can be hidden perfectly behind the mirror by double-sided adhesive tapes. Without any electronic boxes or switches, you can turn ON/OFF the light, dim the level of brightness and change light colour temperatures by touching certain icons printed on the mirror. KZQ-CM-BC, an essential element to achieve minimalism design.



### Functions:

On/off

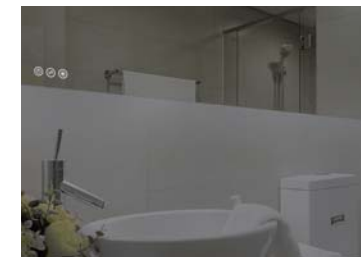

Dimming



Colour temperature adjustable



**NEW**



Wiring Diagram:

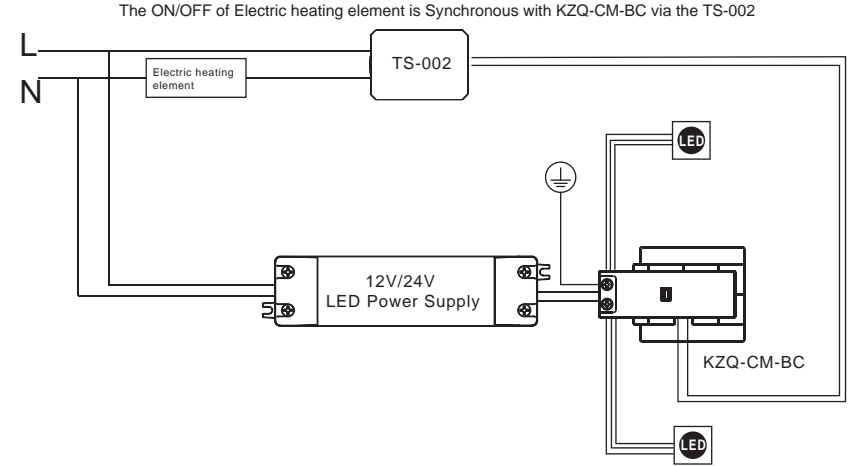

**KZQ-CM-BC**

Rated input	Rated load	ta	Thickness of mirror
DC 12V	2 x 30W	-20~35°C	Less than 6mm is recommended
DC 24V	2 x 60W		

- Touch sensor
- Used behind mirror
- Memory function

Accessories:

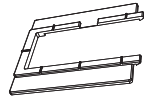

Installation bracket with double-sided adhesive tape

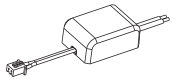

TS-002 (Optional) (12V or 24V version)

Dimension(mm)

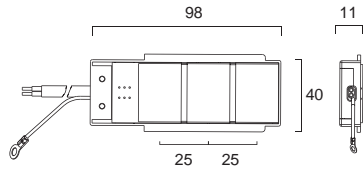

Function:

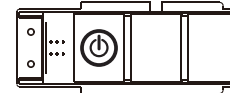
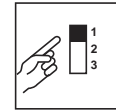

- ⏻ Short touch(< 1s): On/Off
- ⏻ Long touch(> 1s): Dimming from 5%~100%

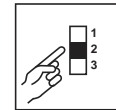

- ⏻ Short touch(< 1s): On/Off
- ⏻ Long touch(> 1s): Dimming from 5%~100%
- ↔ Short touch(< 1s): adjust CCT to cold white, nature white, warm white
- ↔ Long touch(> 1s): adjust CCT from cold white to warm white

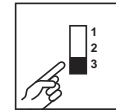

- ⏻ Short touch(< 1s): On/Off
- ↔ Short touch(< 1s): adjust CCT to cold white, nature white, warm white
- ↔ Long touch(> 1s): adjust CCT from cold white to warm white

- ☼ Short touch(< 1s): Dimming level 5%,30%,60%,100%
- ☼ Long touch(> 1s): Dimming from 5%~100%